



**MADAR**  
مدر مهندسون استشاريون

# WORK SAMPLES

PREVIOUS WORK

Project	Location	Scope of work	Type
Strategic Food Security Facilities	Doha, Qatar	3d Rendering	Industrial building
Al Karamah Residential Complex	Muskat, Sultanet Oman	Design	Residential and Commercial
Al Manial Restaurants hub	Cairo, Egypt	Design	Commercial Building
Al Taif Honey Factory	Al Taif, KSA	Design	Public Building
Bashaer El Kheir 2 Mosque	Desert road	Design	Religious Building
Divan Cafe	Jeddah, KSA	Design	Commercial Building
IGI Headquarters	6th of October, Egypt	Design	Administration Building
Jeddah Sales Office	Jeddah, KSA	Design	Administration Building
King Mariout Private Residence Compound	Alexandria, Egypt	Design	Residential Building
Modern Smart School	Borg El arab, Alexandria	Design	Educational Building
Mr. Alaa El Sabagh Villa	North Coast, Alexandria	Design	Residential Building
Mr. El Wazzan villa	King Mariout, Alexandria	Design	Residential Building
Mr. Fahd Abdul Azim Villa	Jeddah, KSA	Design	Residential Building
Mrs. Rowan El Wazzan Villa	King Mariout, Alexandria	Design	Residential Building
Mrs. Wafaa El Wazzan Villa	King Mariout, Alexandria	Design	Residential Building
Pharos Club	Bahary, Alexandria	Design	Public Building
Reve Residential Compound	Masra Matrouh, Egypt	Design	Residential Building
Saraya Serhank Residential Building	Louran, Alexandria	Design	Residential Building
Silver Corner	Jeddah, KSA	Design	Commercial Building
Star Towers Residential Building	Saba Basha, Alexandria	Design	Residential Building
Al Taif Village Hotel	Al Taif, KSA	Design	Hospitality Building
Zinc Restaurant	Cairo, Egypt	Design	Commercial Building
Excel Complex	San Stefano, Alexandria	Design and Built	Commercial Building
Fish Restaurant	Bahary, Alexandria	Design and Built	Commercial Building

Project	Location	Scope of work	Type
Mori Suchi Restaurant	Cairo, Egypt	Design and Built	Commercial Building
Mr. Atef El Rakh apartment	Kafr Abdou, Alexandria	Design and Built	Residential Building
Tamara Restaurant	6th of October, Egypt	Design and Built	Commercial Building
Louran Hospital Extension	Alexandria, Egypt	Design and Execution drawings	Medical Building
Mr. Abdulaziz Al Othman Villa	Riyadh, KSA	Design and Execution drawings	Residential Building
Mr. Abdullah Al Othman Villa	Riyadh, KSA	Design and Execution drawings	Residential Building
Mr. Hamed Fayez Villa	Jeddah, KSA	Design and Execution drawings	Residential Building
The Square Hotel	Jeddah, KSA	Design and Execution drawings	Hospitality Building
Mr. Aly Ghaly Villa	North Coast, Alexandria	Design and Site Supervision	Residential Building
Reconstruction of Al Nori Complex	Mosul, Iraq	Design_Competition	Public Building
Alexandria Business Association	Alexandria, Egypt	Design_Competition	Administration Building
Alexandria Engineering Club	Saba Basha, Alexandria	Design_Competition	Public Building
Borg El Arab Residential Compound	Alexandria, Egypt	Design_Competition	Residential and Commercial
Dar Al Uloum Library	Sakaka, Al Jouf	Design_Competition	Public Building
Marselia Residential Complex	Miami, Alexandria	Design_Competition	Residential and Commercial
Mozambique Pre-school	Xai Xai, Mozambique	Design_Competition	Educational Building
Observatory Houses	Roccascalegna, Italy	Design_Competition	Public Building
Revitalization of the cosmopolitan Alexandria	Raml Station, Alexandria	Design_Competition	Commercial Building
Science Park	Giza, Egypt	Design_Competition	Public Building
Sednaoui El Khazendar Rehabilitation	Cairo, Egypt	Design_Competition	Public Building
Stanley Office Building	Raml Station, Alexandria	Design_Competition	Administration Building
Suncheon art Platform	Seoul, South Korea	Design_Competition	Public Building
The House of art and culture	Beirut, Lebanon	Design_Competition	Public Building
Abo El Oula Compound	Jeddah, KSA	Execution Drawings	Residential Building
Mr. AbdulAziz Al Sheikh Villa	Jeddah, KSA	Execution Drawings	Residential Building

Project	Location	Scope of work	Type
Mr. Faisal Ghaleb Villa	Riyadh, KSA	Execution Drawings	Residential Building
Al Salam Residential Building	Jeddah, KSA	Facades design	Residential Building
Al Romansia Restaurant	Riyadh, KSA	Interior and Exterior Design	Commercial Building
Al Mashmoul Optics	Jeddah, KSA	Interior Design	Commercial Building
Emerald Residential Building	Smouha, Alexandria	Interior Design	Residential Building
Islamic Development Bank	Jeddah, KSA	Interior Design	Public Building
Mr. Abo Mounir Villa	Riyadh, KSA	Interior Design	Residential Building
Mr. Mohamed Aal Al Sheikh Villa	El Khobar, KSA	Interior Design	Residential Building
Time Hotel	Al Alamein, Alexandria	Interior Design	Hospitality Building
Horus Agriculture trade	El Shatby, Alexandria	Interior Design and Shop Drawings	Administration Building
King's Private Beach	Thuwal, KSA	Landscape Design	Residential Building
Mecca Development projects	Mecca, KSA	Landscape Design	Public Building
Mr. Effat El Sadat Rooftop	North Coast, Alexandria	Landscape Design	Residential Building
Mr. Sameh El Seraity Villa	Ofoq Compound, K 50 Desert Rd	Landscape Design	Residential Building
Al Taif Village	Al Taif, KSA	Landscape Design	Public Building
Time Hotel	Al Alamein, Alexandria	Landscape Design and Facades Design	Hospitality Building
October Gardens Compound	6th of October, Egypt	Landscape Design and Shop Drawings	Residential Building
Palmino Residence Compound	North Coast, Alexandria	Landscape Design and Shop Drawings	Residential Building
Al Haram Hotel	Cleopatra, Alexandria	Rehabilitation	Hospitality Building
EBS School Theater	El Shatby, Alexandria	Rehabilitation	Educational Building
Nalco Champion Company	Free zone, Alexandria	Rehabilitation	Administration Building
L'ingilterra Hotel	Rome, Italy	Shop Drawings	Hospitality Building
Ministry of Justice	New Capital, Egypt	Shop Drawings	Government building
Presidential Palace	Al Alamein, Alexandria	Shop Drawings	Government building

ARCHITECTURE  
and LANDSCAPE  
WORK SAMPLES



uia

الموصل  
#ReviveTheSpiritOfMosul

UNESCO  
United Nations  
Educational, Scientific and  
Cultural Organization



United Nations  
Educational, Scientific and  
Cultural Organization





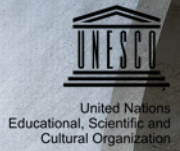









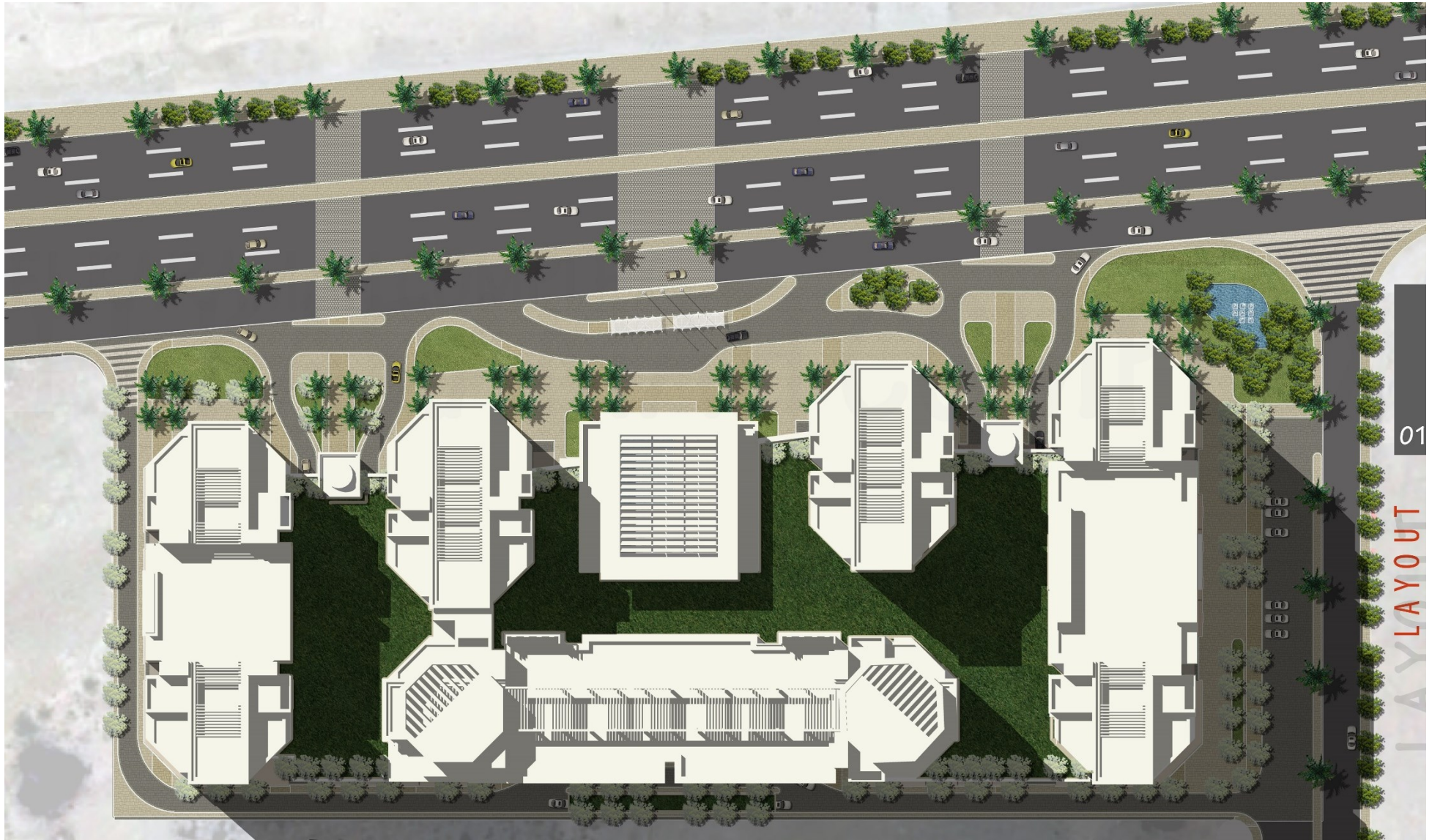









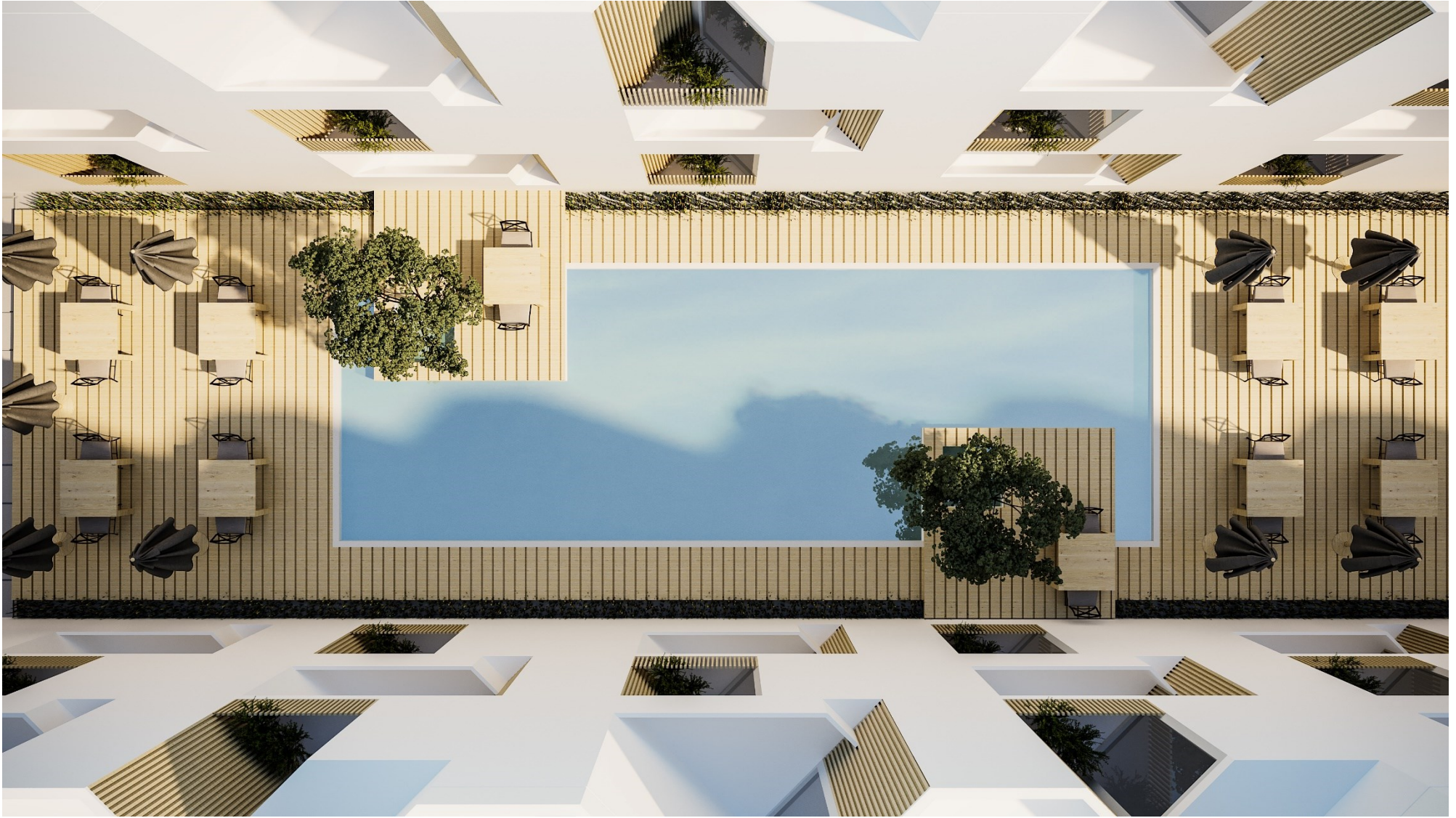























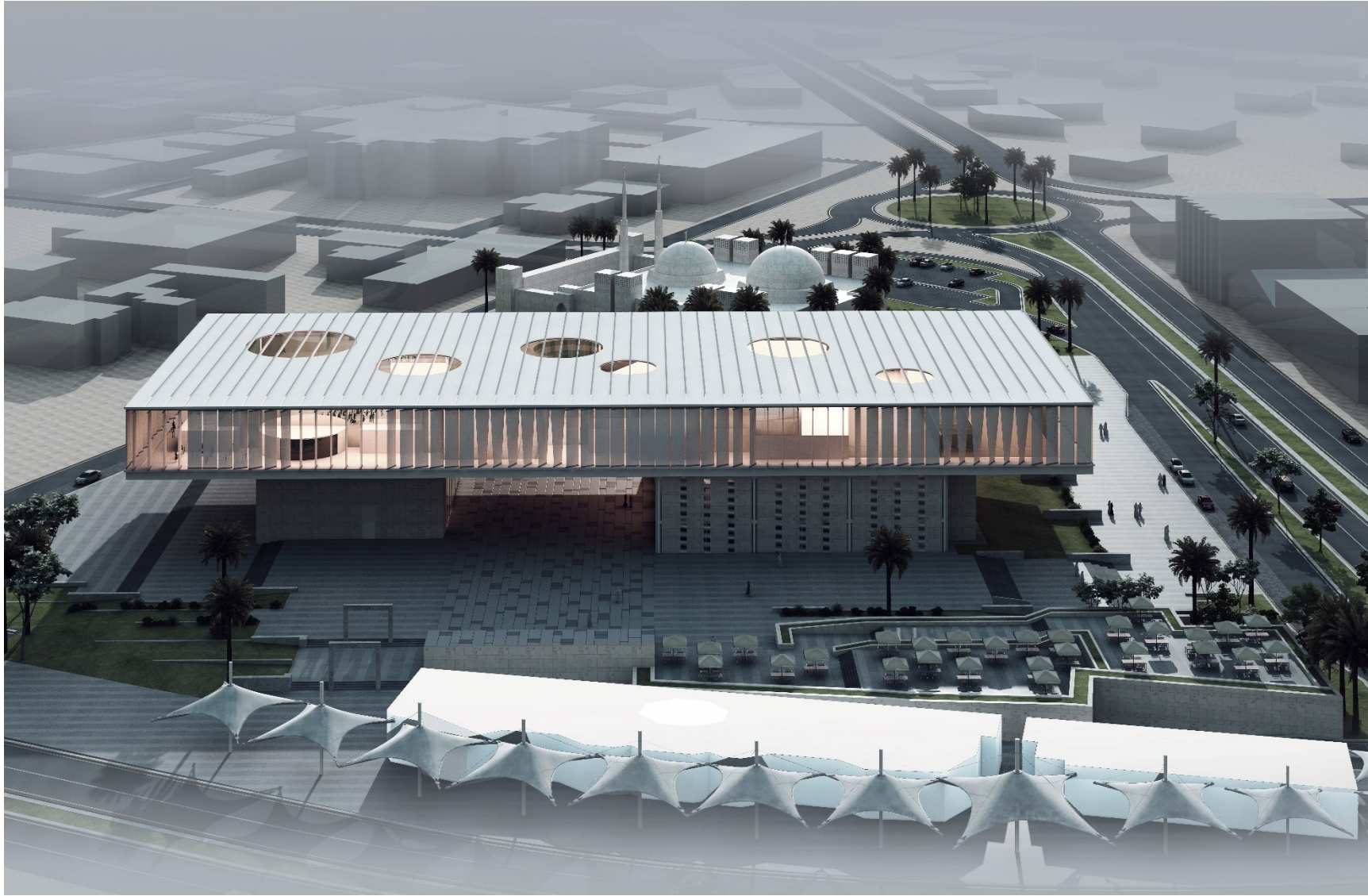











INTERIOR DESIGN  
WORK SAMPLES



















































BIM & SHOP DRAWINGS  
WORK SAMPLES

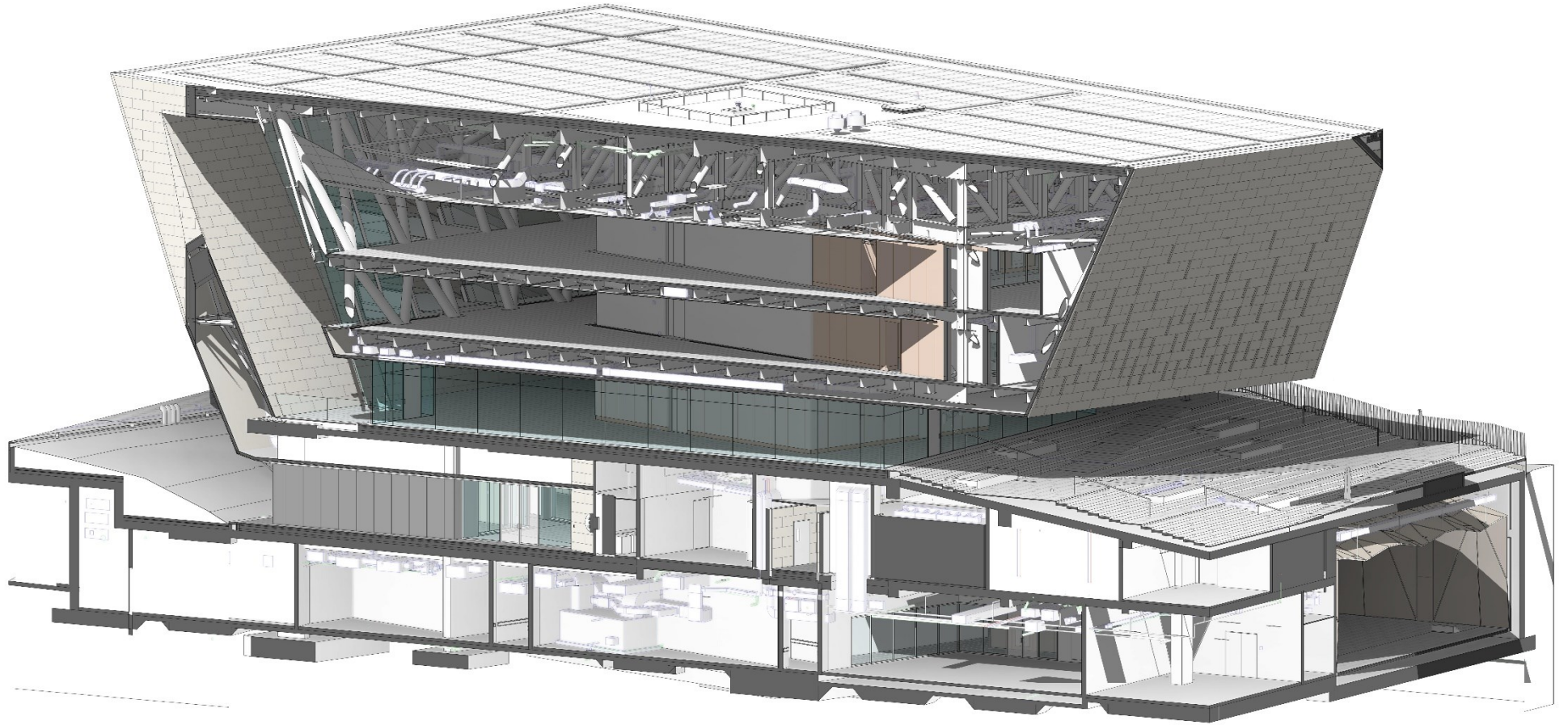

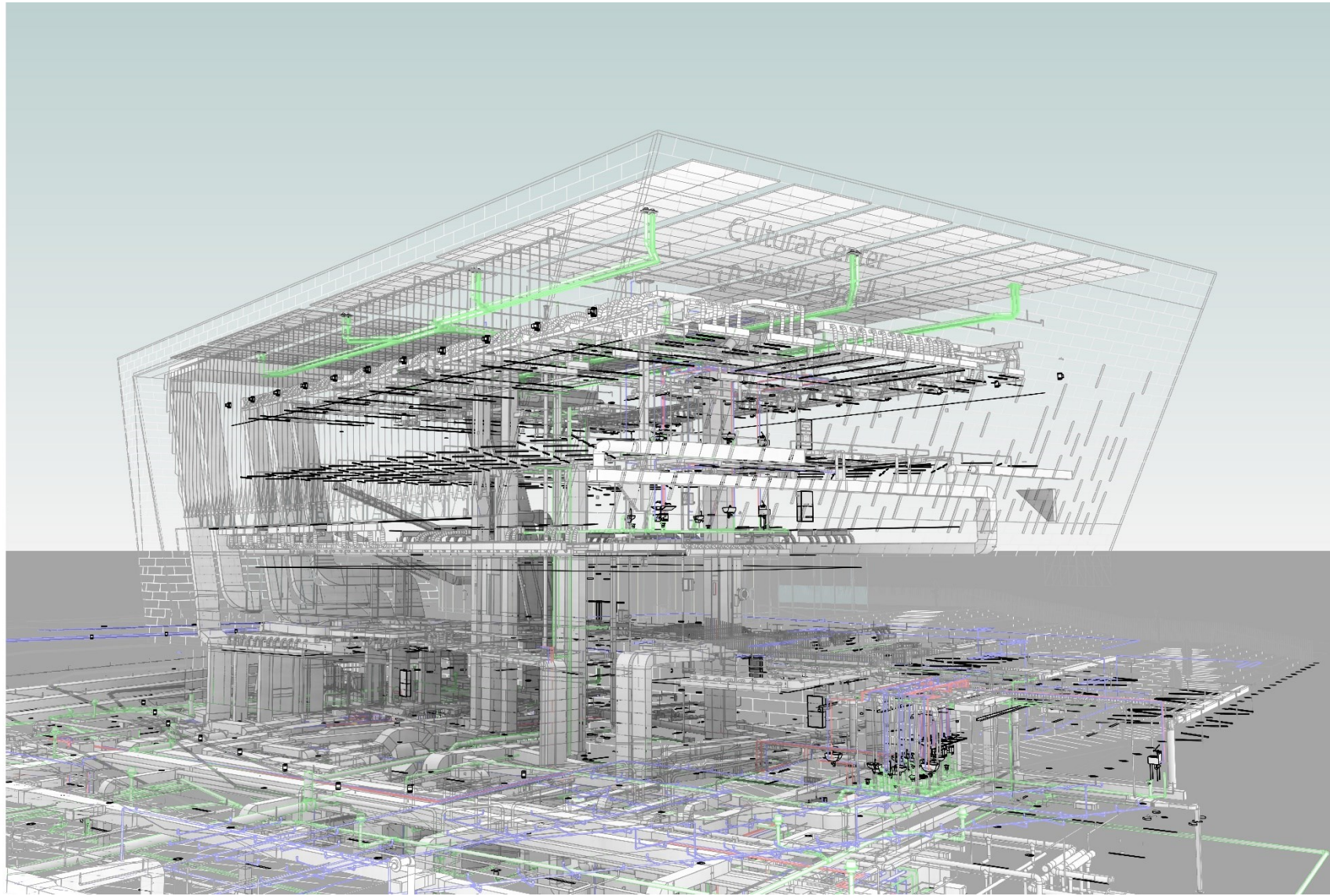

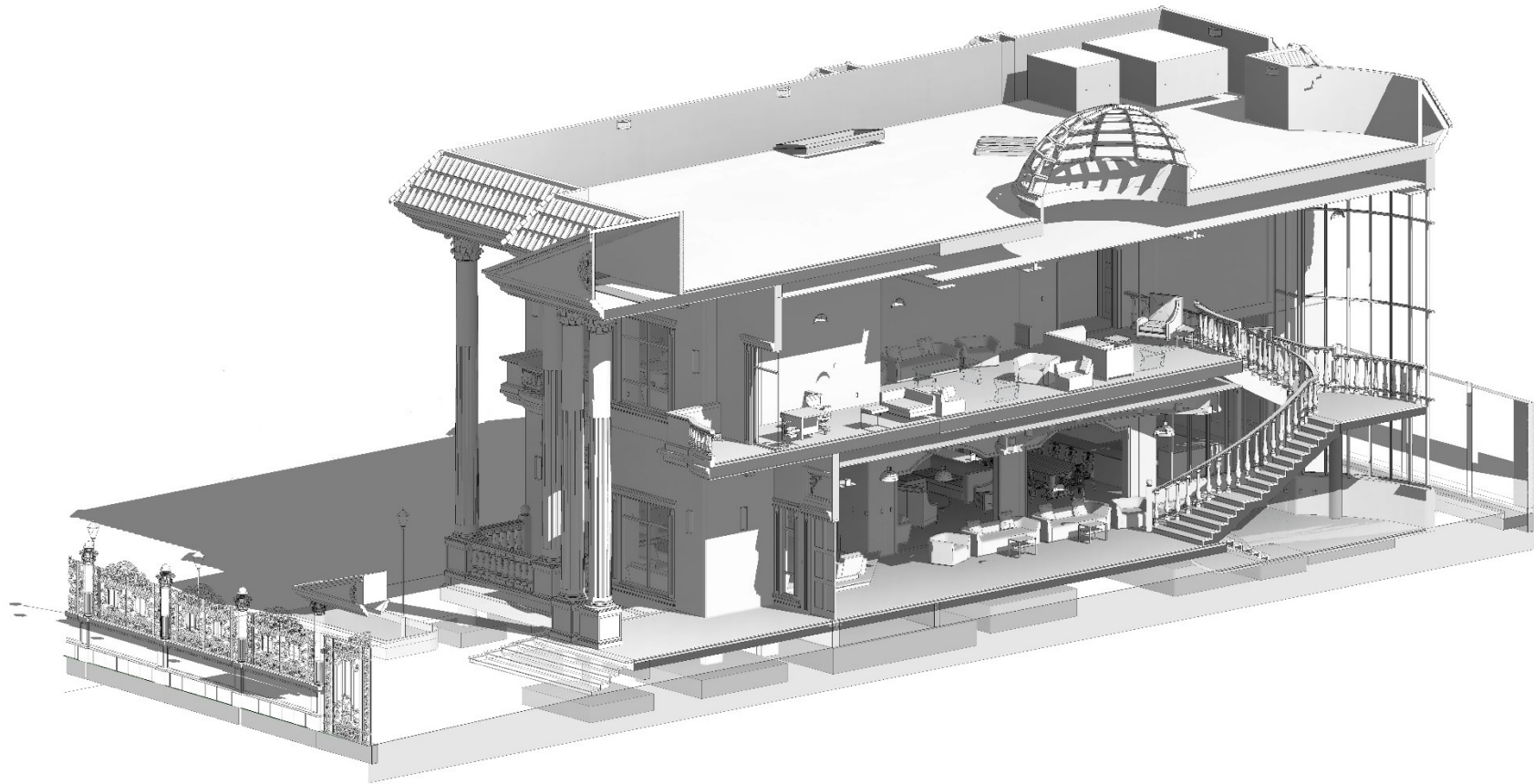

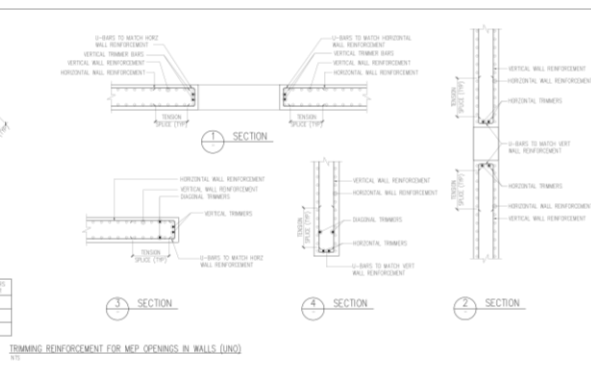
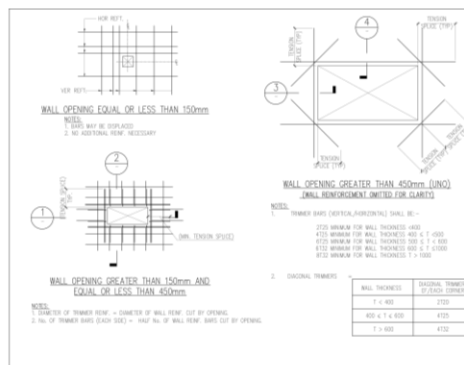
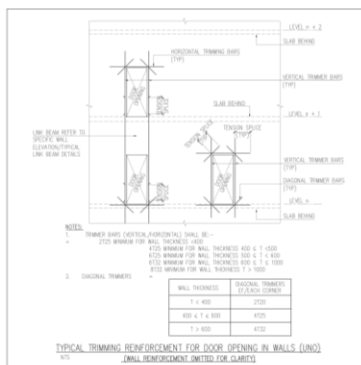
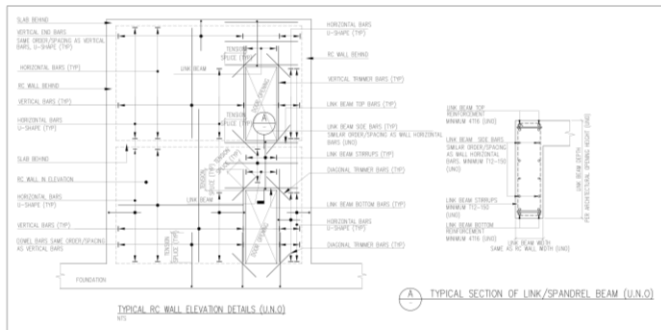
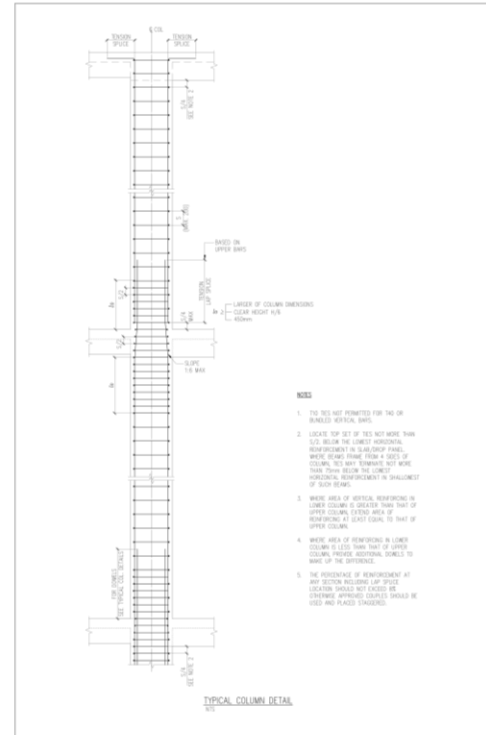
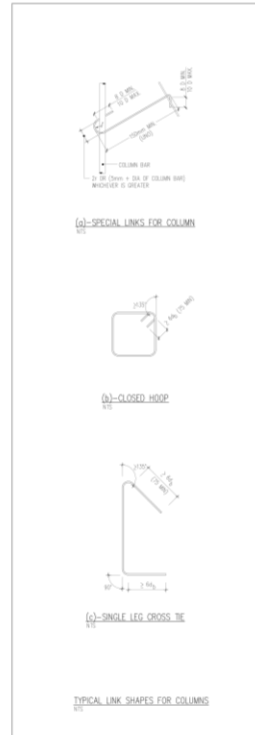
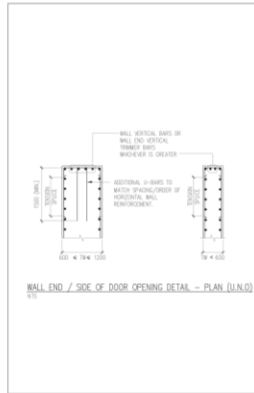
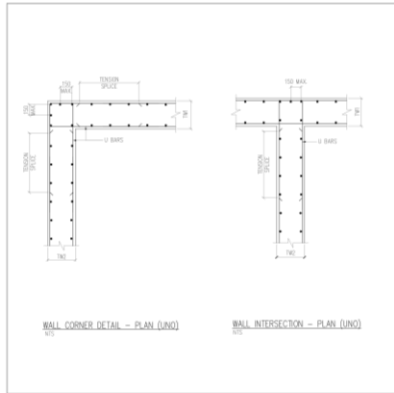



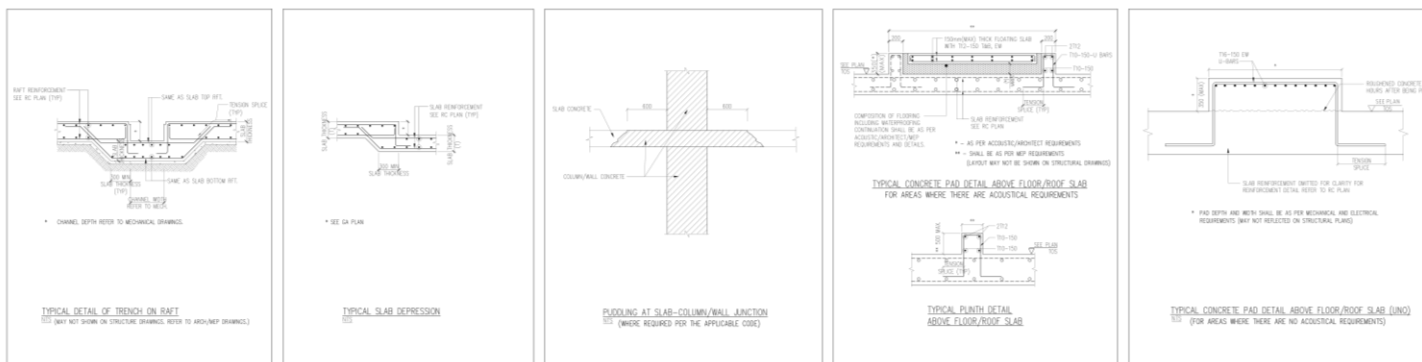
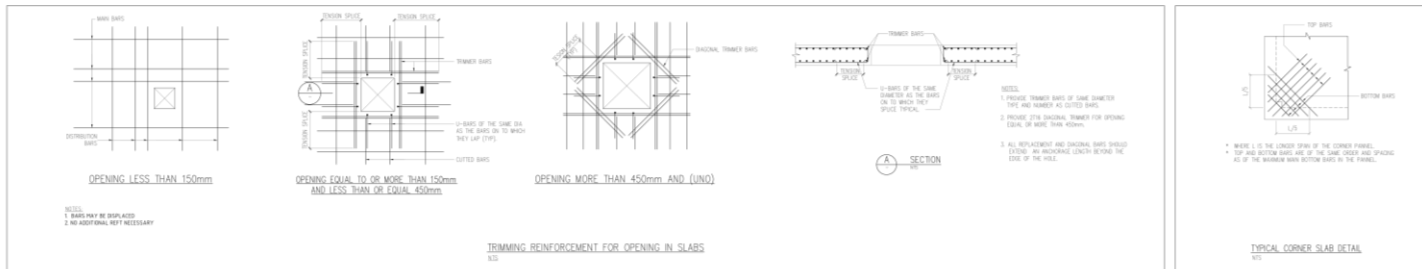
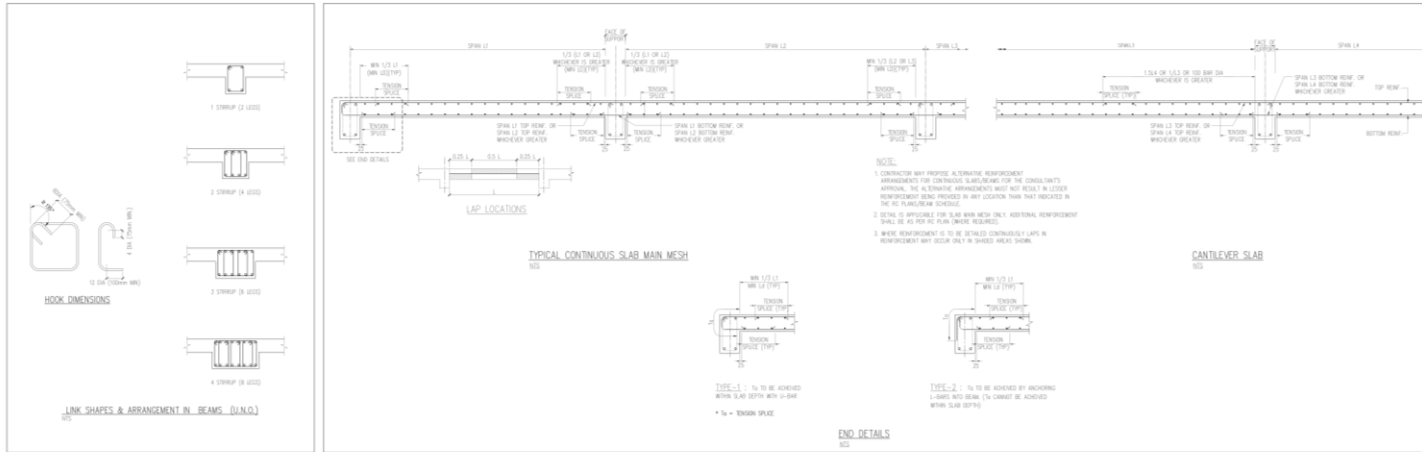

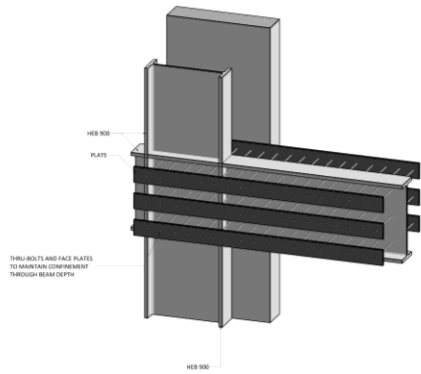

1  
100 STEEL CONFINEMENT DETAIL (PLATE)

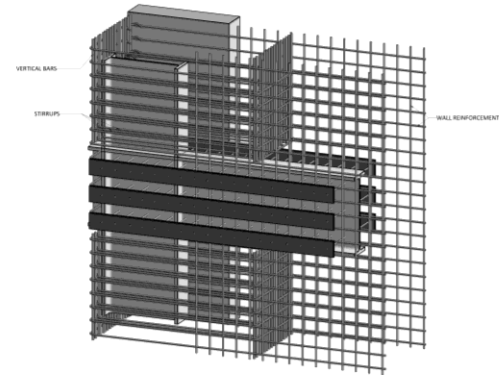

2  
100 STEEL CONFINEMENT DETAIL (REINFORCEMENT)

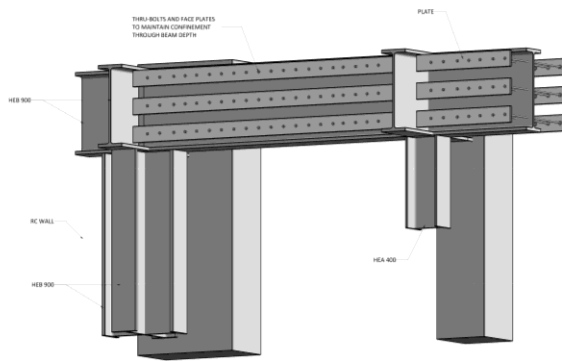

3  
100 STEEL CONFINEMENT DETAIL (PLATE)

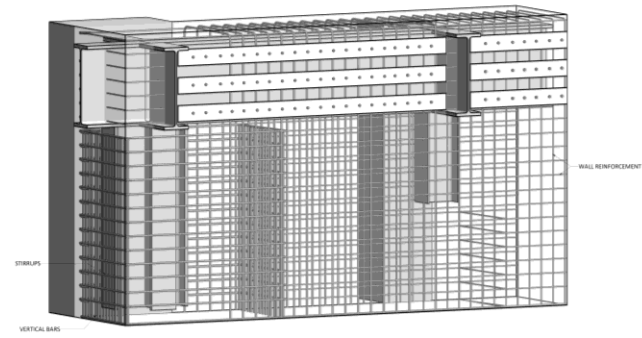

4  
100 STEEL CONFINEMENT DETAIL (REINFORCEMENT)

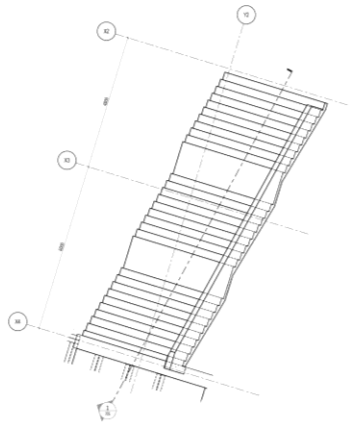

1 FEATURE STAIR PLAN AT UPPER GROUND  
1:50

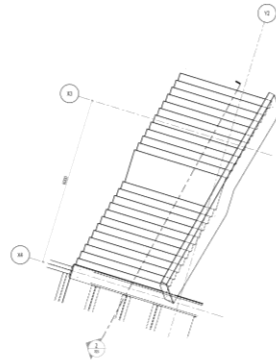

2 FEATURE STAIR PLAN AT FIRST FLOOR  
1:50

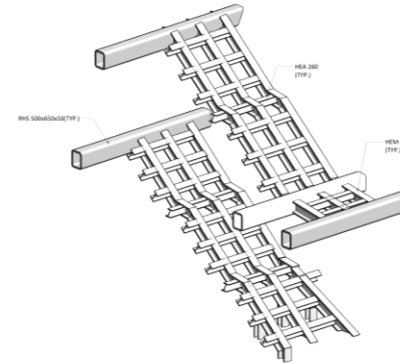

3 FEATURE STAIR STEEL SECTIONS  
1:50

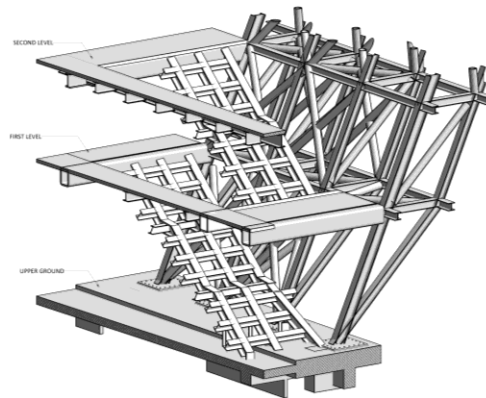

4 FEATURE STAIR-3D VIEW  
1:50

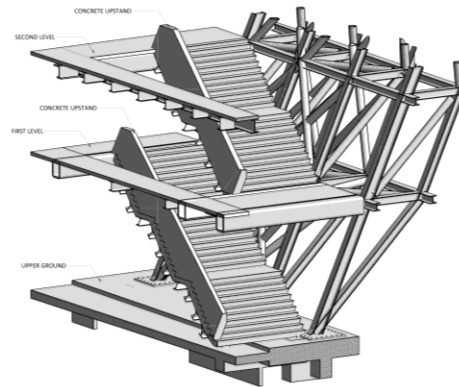

5 FEATURE STAIR WITH CONCRETE-3D VIEW  
1:50

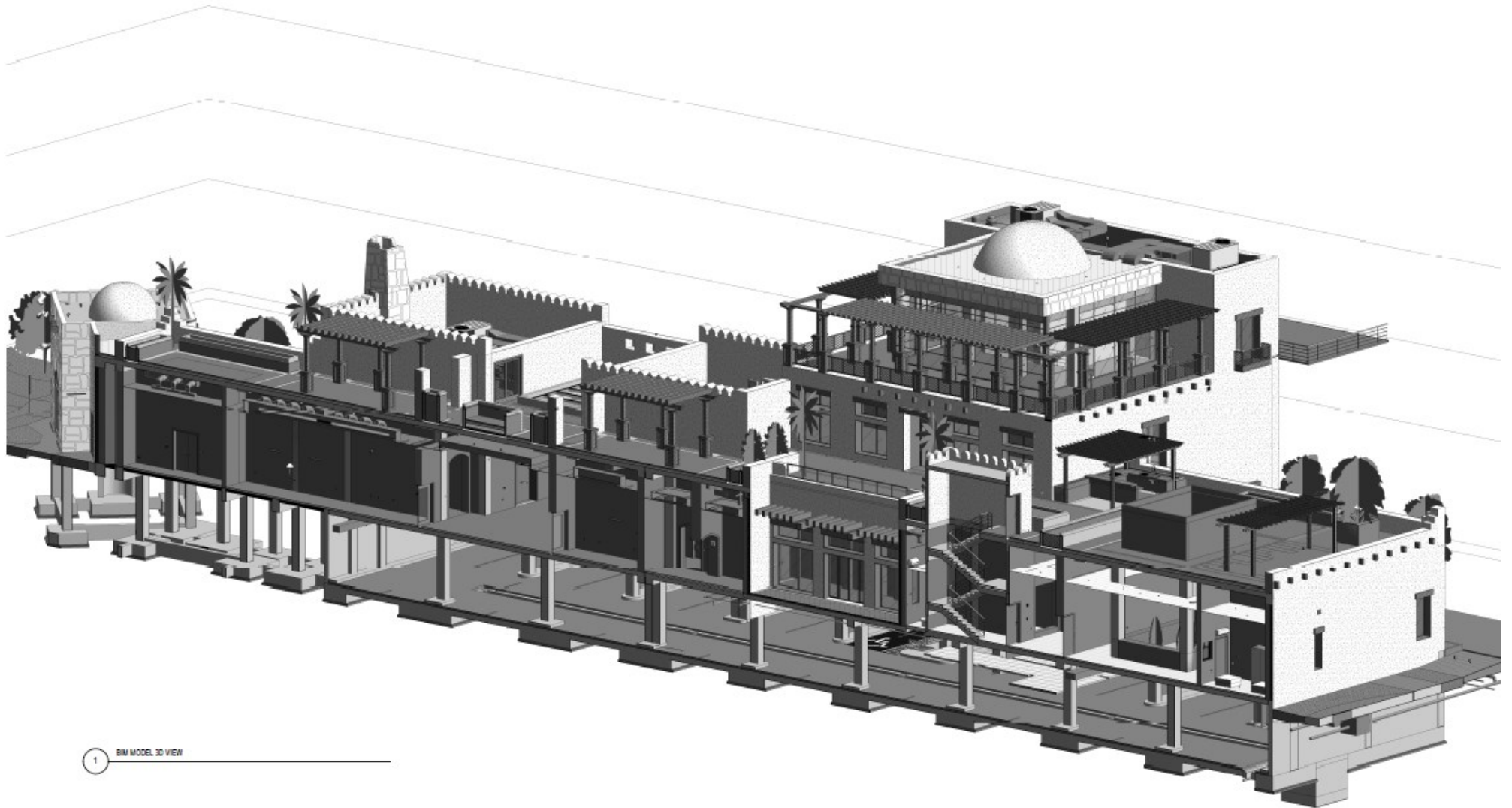

1 BIM MODEL 3D VIEW

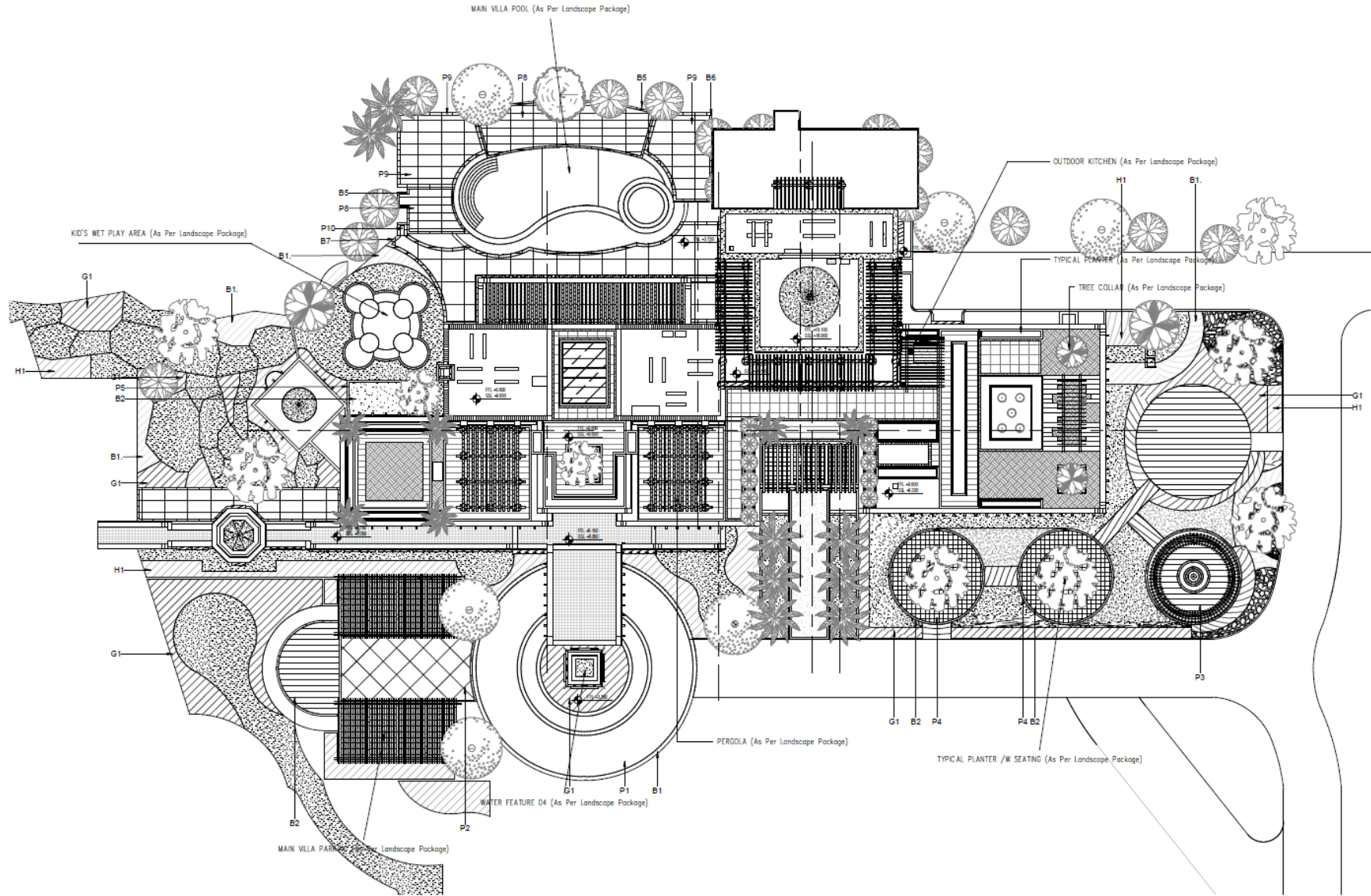

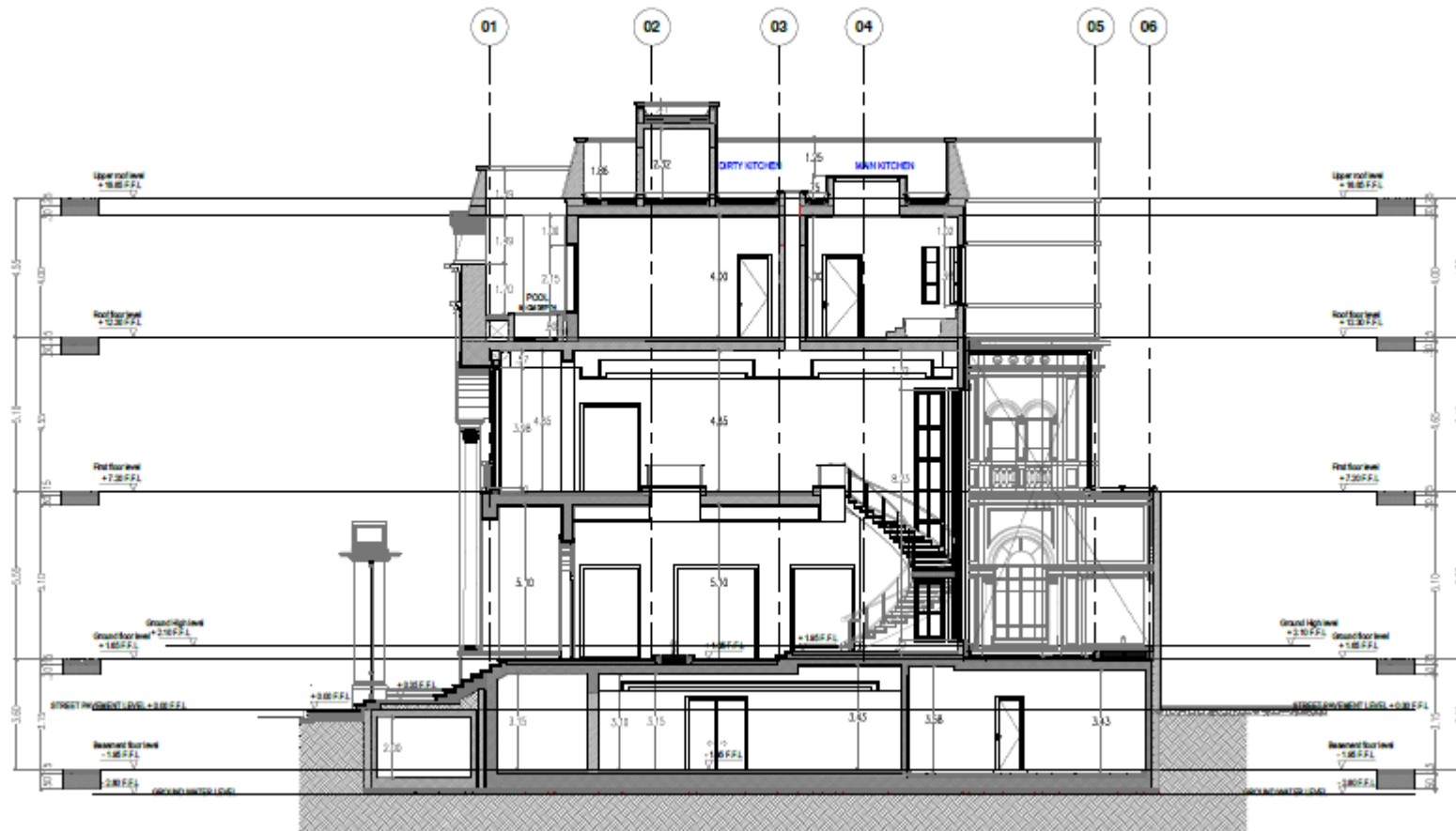

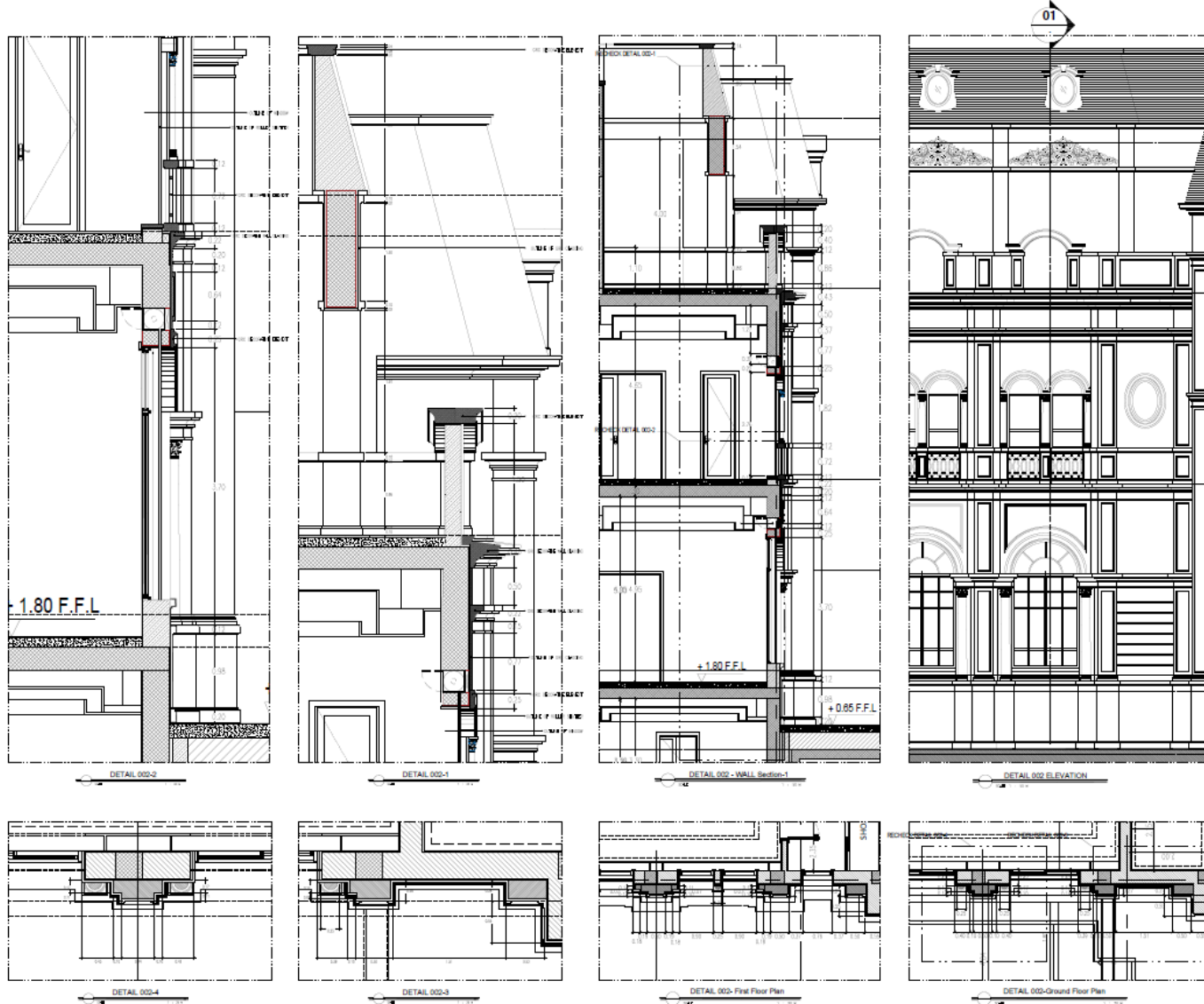

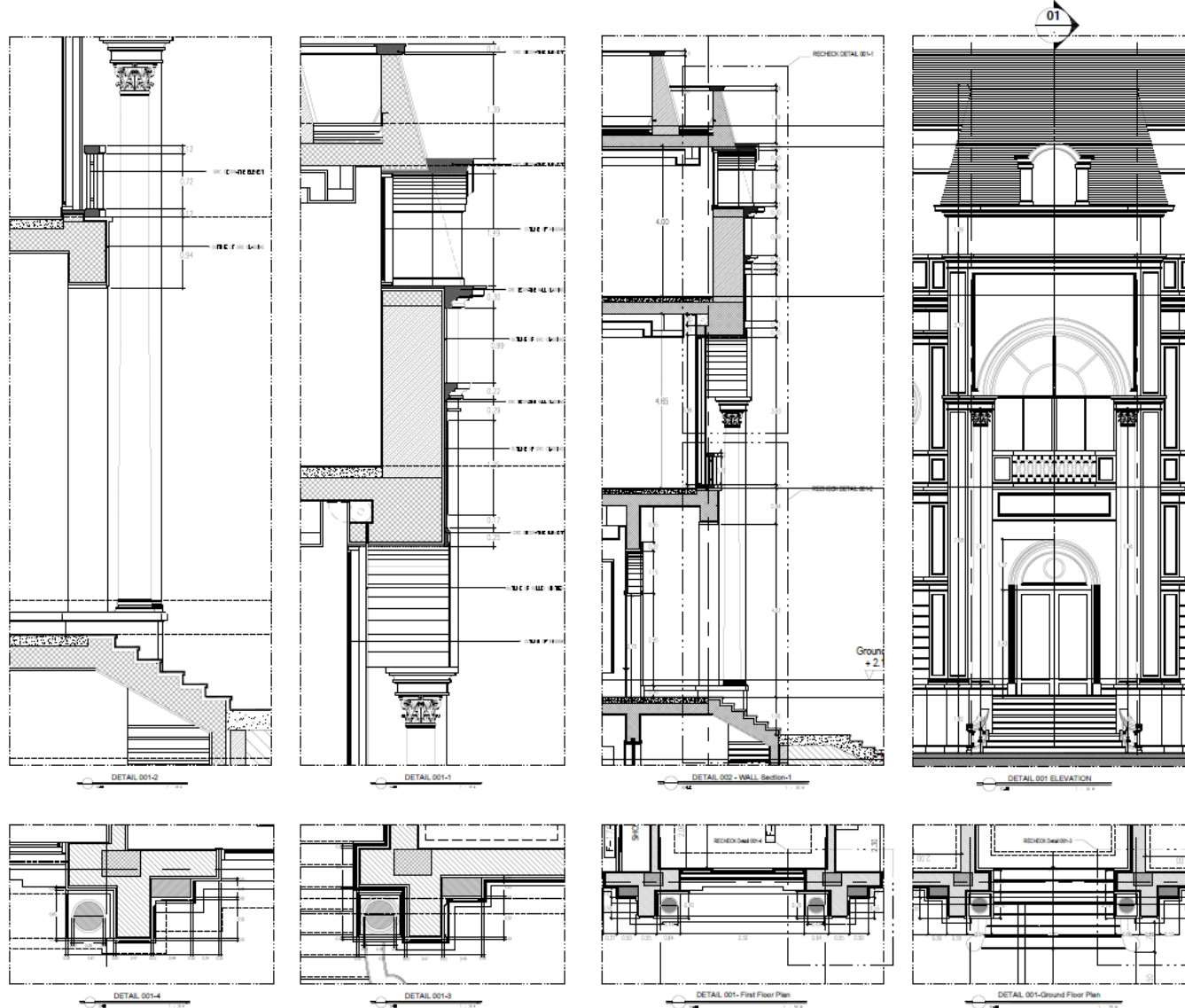

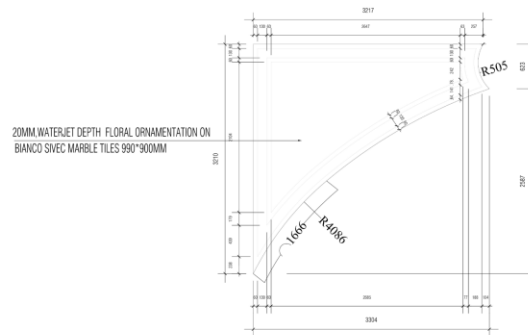

**ID 01**  
DETAIL (01)  
1:20

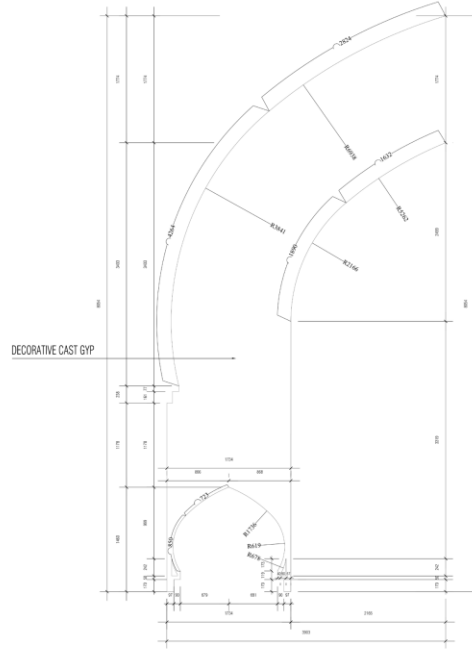

**ID 02**  
MEHRAB DETAIL (02)  
1:20

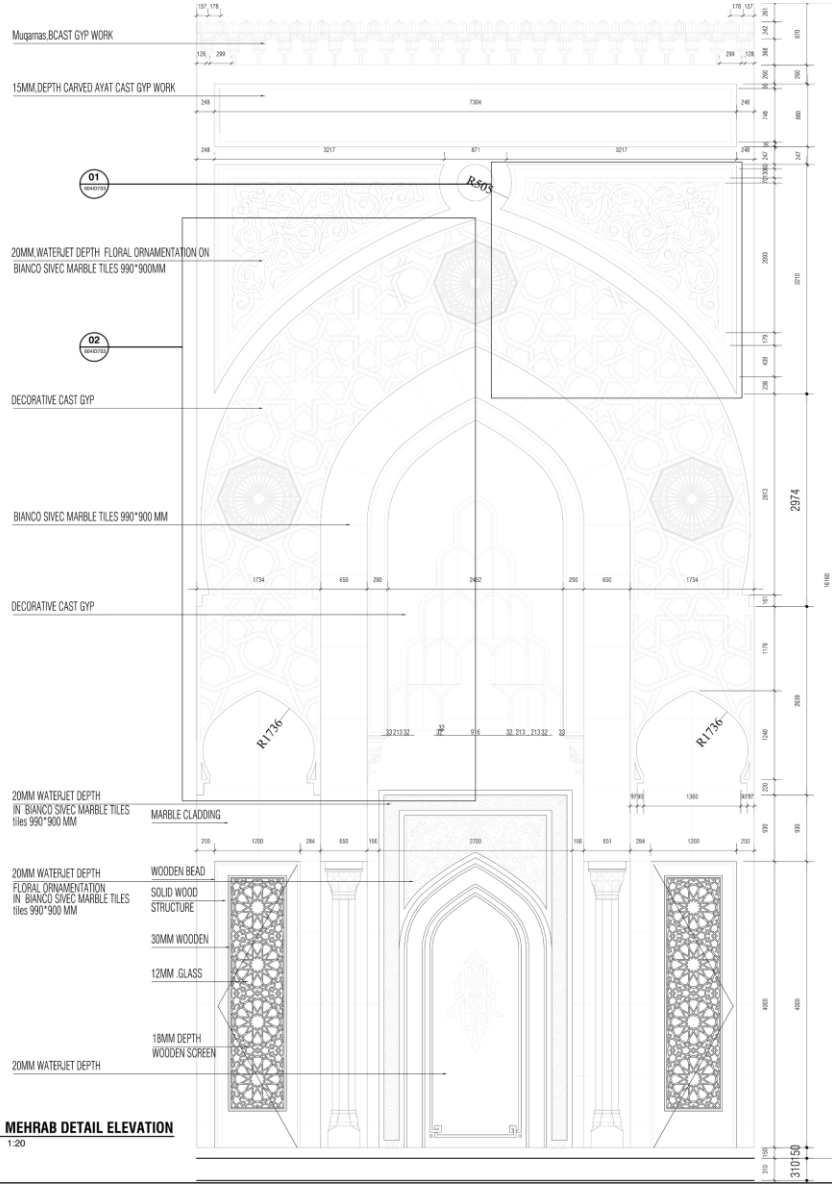

**ID 03**  
MEHRAB DETAIL ELEVATION  
1:20

